













ref. 75

TRANSFORMADOS
DUMYPARK

-  11 kg
-  80 L
-  0,50 m³
-  Ok
- 
 -  RAL 3002
 -  RAL 5010
 -  RAL 6016
 -  RAL 1021
 -  RAL 9016
 -  RAL 9011
 -  Oxidón
 -  Oxidón

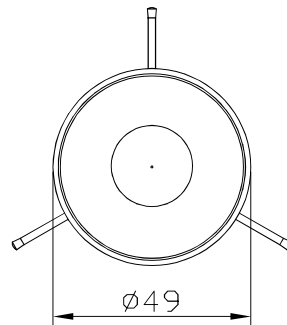
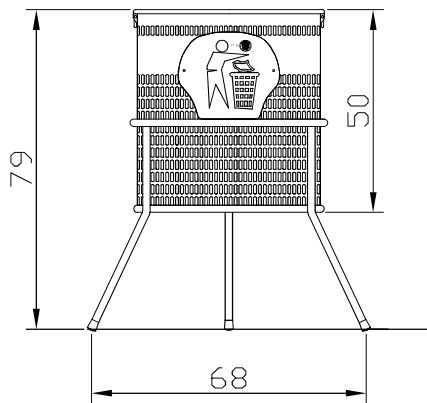

Printed in  100%

