







ref. 200351

TRANSFORMADOS
DUMYPARK

-  EN-1176
-  1-4
-  124 cm
-  26,2 m²
-  108 kg
-  Ok

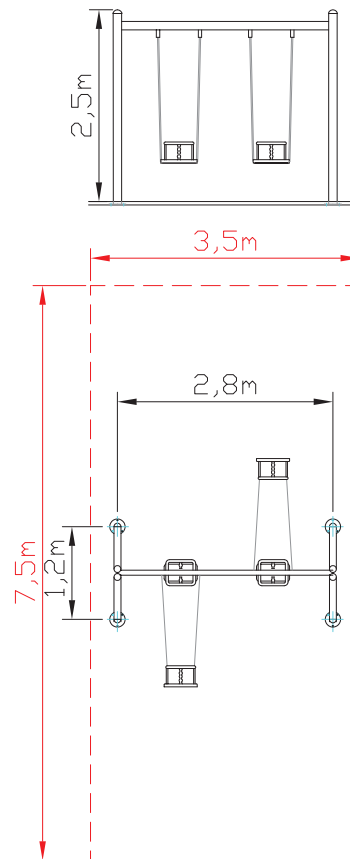

Printed in  100%

