







ref. 200350

TRANSFORMADOS
DUMYPARK

-  EN-1176
-  3-12
-  124 cm
-  26,2 m²
-  100 kg
-  Ok



 1-12 ref. 200350NM

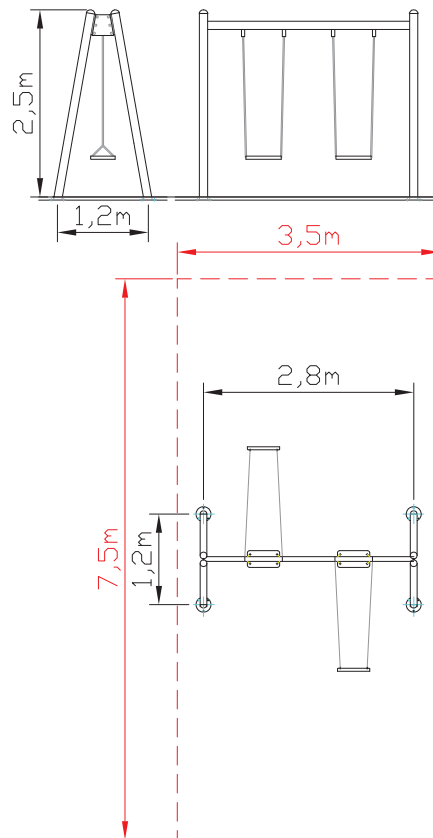

Printed in  100%

