





ref. 354

TRANSFORMADOS  
**DUMYPARK**

-  EN-1176
-  3-8
-  120 cm
-  19,2 m<sup>2</sup>
-  70 kg
-  Ok
- 

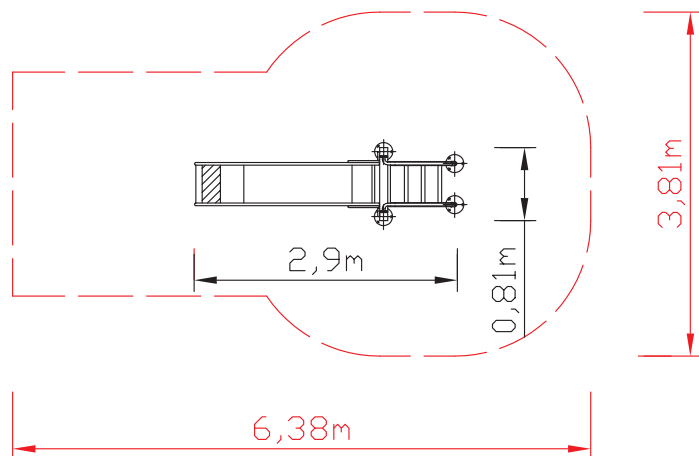
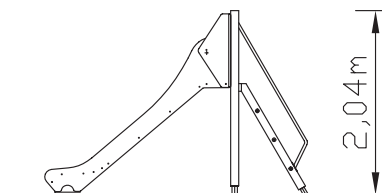

Printed in  100%

